

Article number: 2301072701

Description: E+G Handwheel  
VDS.125+I-A12

## Measures

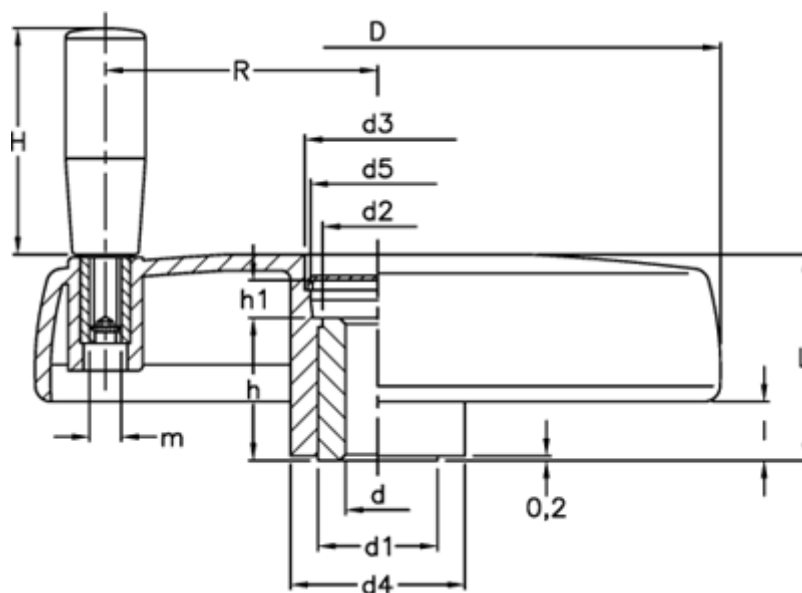

C (N m) = 125	H = 56
D = 125	h = 27
d1 = 26	h1 = 8
d2 = 24.0	l = 11
d3 = 31.0	L = 39
d4 = 35	L (J) = 25
d5 = 28	m = M6
d H7 = 12	R = 49.0